

VOLUMEN (l)

MAX. OBREMENITEV (Kg)

OBREMENITEV TAL (Kg/m<sup>2</sup>)

VOLUMEN (l)

MAX. OBTEREČENJE (Kg)

OBTEREČENJE PODA (Kg/m<sup>2</sup>)

385

500

260

- - Prostor za el. vodnik 3 x 1,5 mm<sup>2</sup>, oziroma 3x2,5 mm<sup>2</sup> za kombinirane sisteme dolžine cca 1m.
- - Mjesto za el. vodnik 3 x 1,5 mm<sup>2</sup>, odnosno 3x2,5 mm<sup>2</sup> za kombinirane sisteme dužine cca 1m.
- - Prostor za el. vodnik 1 x 6 mm<sup>2</sup> za ozemljitev, dolžine cca 1,5m.
- - Mjesto za el. vodnik 1 x 6 mm<sup>2</sup> za ozemljenje, dužine cca 1,5m.

- ⊠ - Priklop tople in hladne vode 1/2" min 2 max 4 bar
- ⊠ - Priključak tople i hladne vode 1/2" min 2 max 4 bar

- - Prostor za odtok ø 50 mm
- - Mjesto za odtok ø 50 mm

- ⊞ - Opcija-obloga
- ⊞ - Opcija-obloga

PREDLOG VGRADNJE  
PRIJEDLOG UGRADNJE

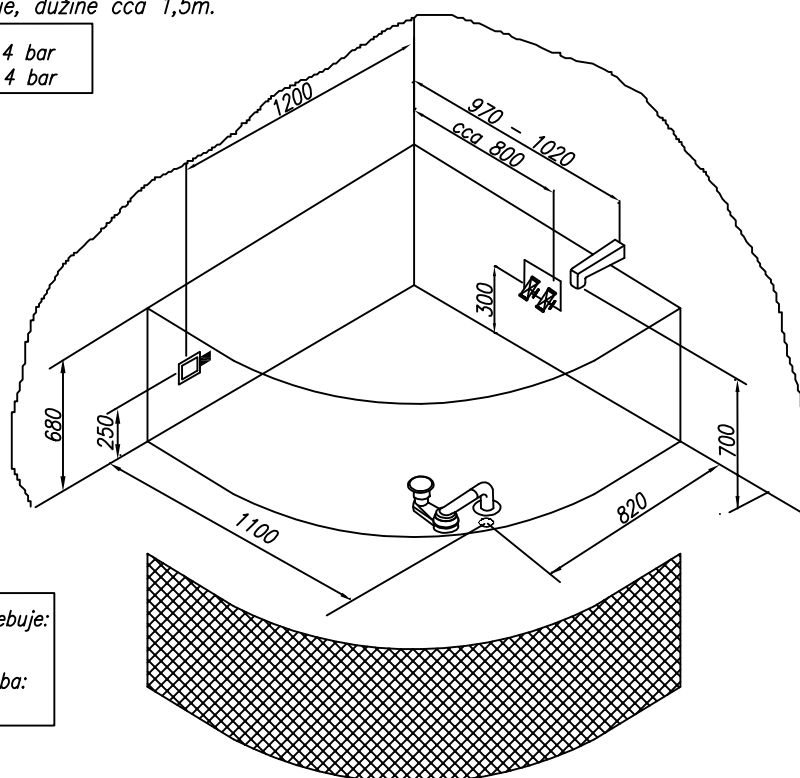

- ⊠ - POZOR - masažni sistem RELAX OBVEZNO potrebuje: Priklop hladne vode 1/2" min 2 max 4 bar
- ⊠ - PAŽNJA - masažni sistem RELAX OBAVEZNO treba: Priključak hladne vode 1/2" min 2 max 4 bar

- |  |  |   |  |  |
|--|--|---|--|--|
|  - VODNA ČRPALKA<br>- CRPKA ZA VODU        |  - VODNE ŠOBE<br>- VODNE MLAZNICE   |  - REGULATOR ZRAKA<br>- REGULATOR ZRAKA        |  - ELEKTRONSKA STIKALA<br>- ELEKTRONSKI PREKIDAČI         |  - ARMATURA IN TUŠ ROČICA<br>- PIPA I TUŠ                 |
|  - ZRAČNI KOMPRESOR<br>- ZRAČNI KOMPRESOR |  - ZRAČNA ŠOBA<br>- ZRAČNA MLAZNICA |  - PNEVMATSKO STIKALO<br>- PNEVMATSKI PREKIDAČ |  - LUČ ALI CHROMOTERAPIJA<br>- SVJETLO ILI CHROMOTERAPIJA |  - PREKLOPNIK ZA MIKROŠOBE<br>- PREKIDAČ ZA MIKROMLAZNICE |

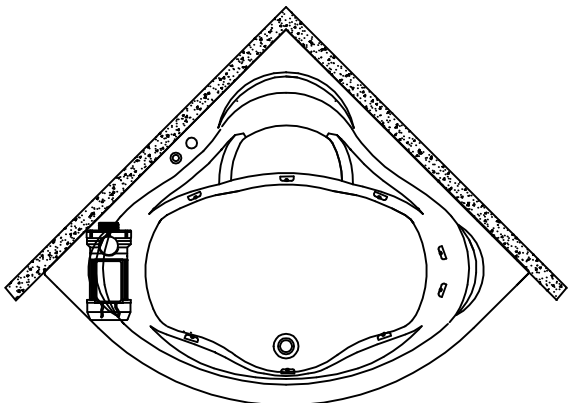

- VODNI MASAŽNI SISTEM 1**      **VODNI MASAŽNI SISTEM 1**
- VODNA ČRPALKA P= 1,25 KW
  - PNEVMATSKO STIKALO
  - REGULATOR ZRAKA
  - 8 VODNIH ŠOB

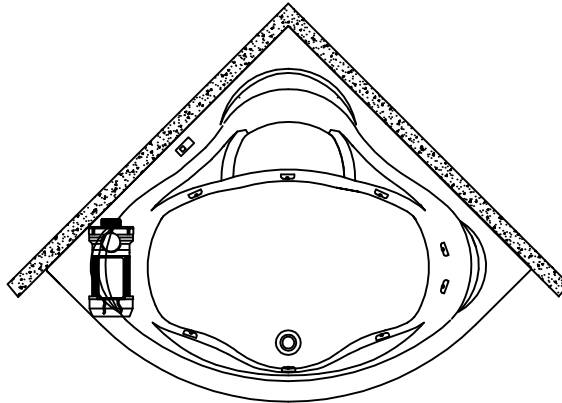

- VODNI MASAŽNI SISTEM 2**      **VODNI MASAŽNI SISTEM 2**
- VODNA ČRPALKA P= 1,25 KW
  - ELEKTRONSKO STIKALO
  - 8 VODNIH SUPER ŠOB

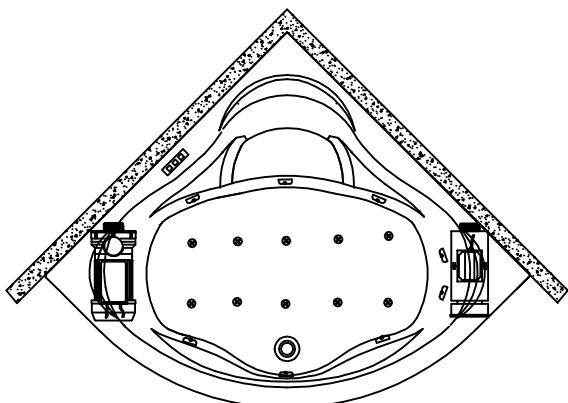

- VODNI IN ZRAČNI MASAŽNI SISTEM**      **VODNI I ZRAČNI MASAŽNI SISTEM**
- VODNA ČRPALKA P= 1,25 KW
  - ZRAČNI KOMPRESOR P=0,8KW
  - ELEKTRONSKO STIKALO
  - 8 VODNIH ŠOB
  - 10 ZRAČNIH ŠOB

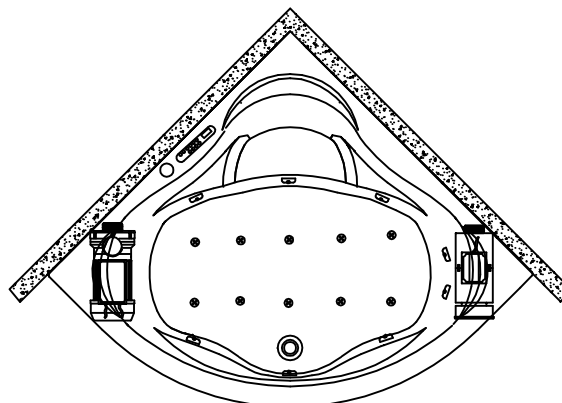

- LUXUS MASAŽNI SISTEM**      **LUXUS MASAŽNI SISTEM**
- VODNA ČRPALKA P=1,1 KW
  - ZRAČNI KOMPRESOR P=0,8KW
  - GRELEC P=1,5 KW
  - ELEKTRONSKO STIKALO
  - REGULATOR ZRAKA
  - 8 VODNIH ŠOB
  - 10 ZRAČNIH ŠOB
  - SISTEM ZA DEZINFEKCIJO
  - LUČ

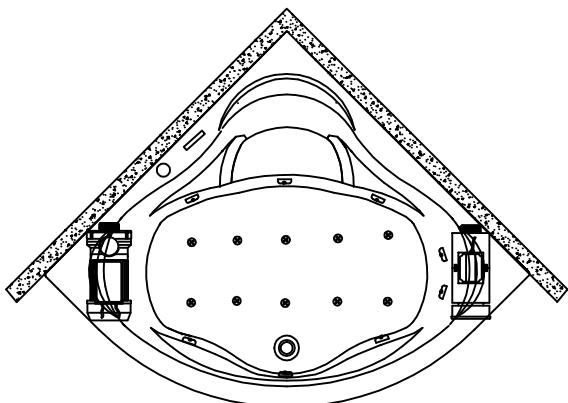

- RELAX MASAŽNI SISTEM**      **RELAX MASAŽNI SISTEM**
- VODNA ČRPALKA P= 1,25 KW
  - ZRAČNI KOMPRESOR P=0,8 KW
  - GRELEC 1,5 KW
  - ELEKTRONSKO STIKALO
  - REGULATOR ZRAKA
  - 8 SUPER VODNIH ŠOB
  - 10 ZRAČNIH ŠOB
  - CHROMOTERAPIJA
  - BATHRELAX SYSTEM
  - WATERSTIM SYSTEM
  - ELEKTRO VENTIL ZA IZPIRANJE (OBVEZEN PRIKLOP VODE)

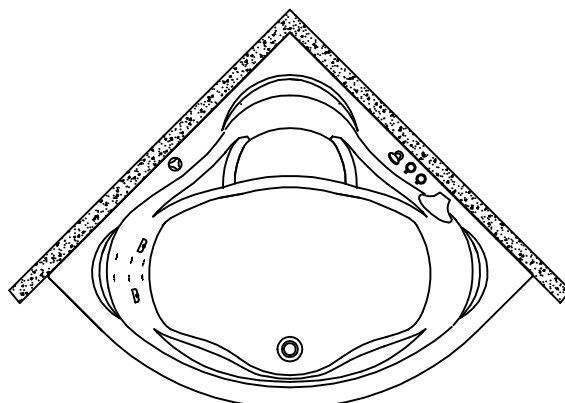

- OPCIJA ARMATURA IN TUŠ ROČICA
- OPCIJA BATHRELAX
- OPCIJA CHROMOTERAPIJA
- OPCIJA MIKROŠOBE 6
- OPCIJA SUPER VODNE ŠOBE
- OPCIJA DVE DODATNI ŠOBI

- OPCIJA PIPA I TUŠ
- OPCIJA BATHRELAX
- OPCIJA CHROMOTERAPIJA
- OPCIJA MIKROMLAZNICE 6
- OPCIJA SUPER VODNE MLAZNICE
- OPCIJA DVIJE DODATNE MLAZNICE